

Schémas de raccordement

Switchs SPE raccordés en série

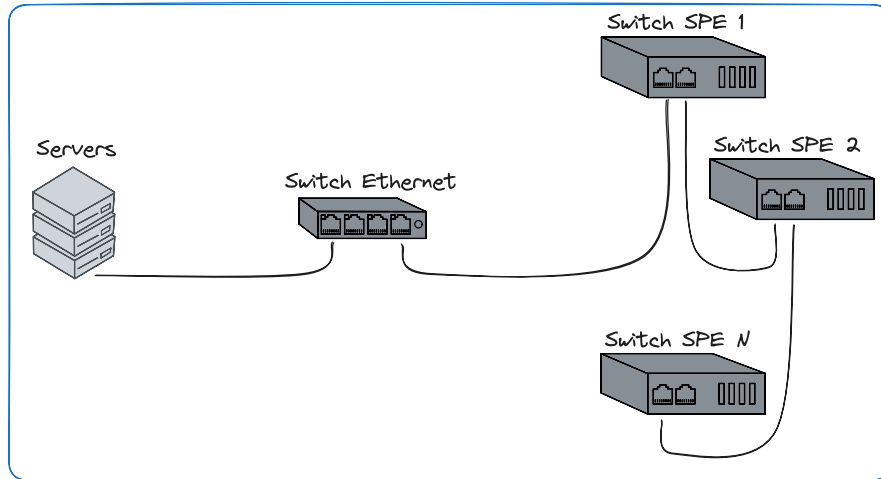

Switchs SPE raccordés en "étoile"

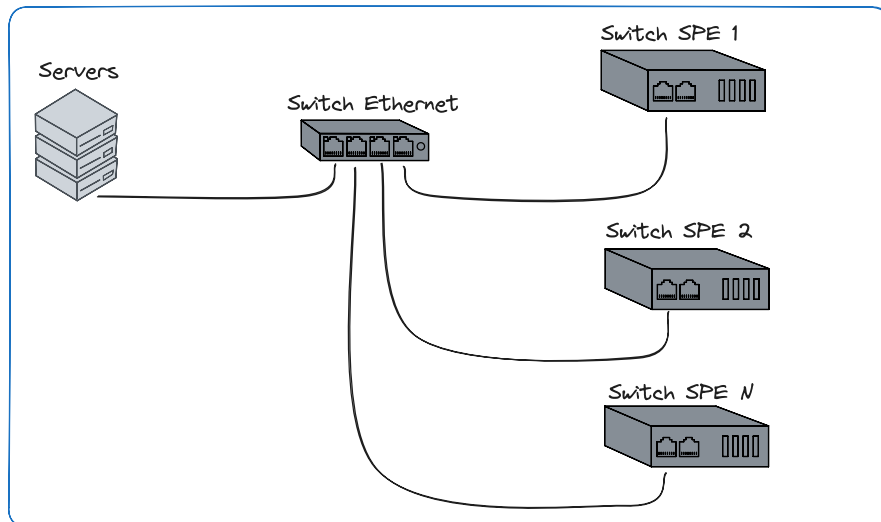

Une topologie hybride est également possible.

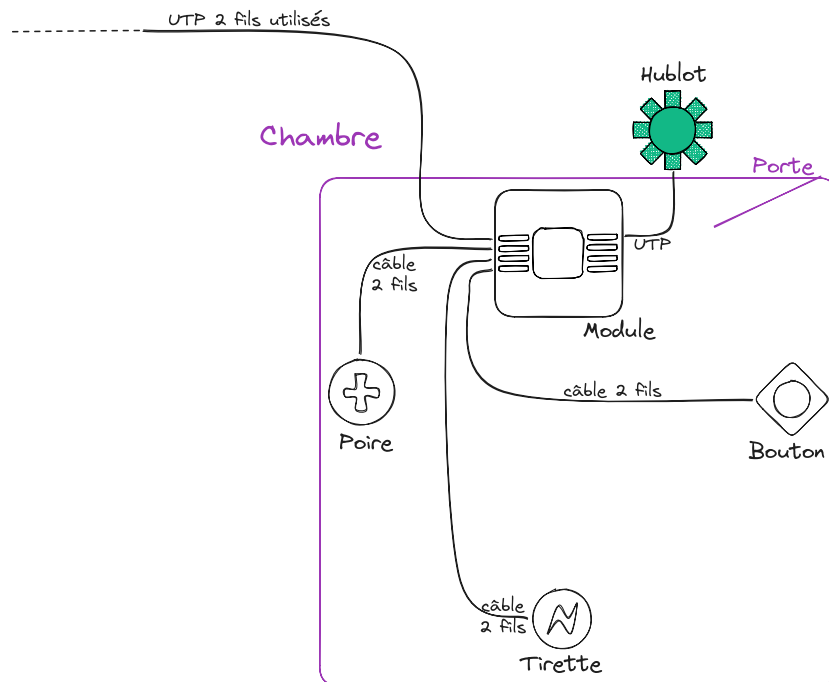
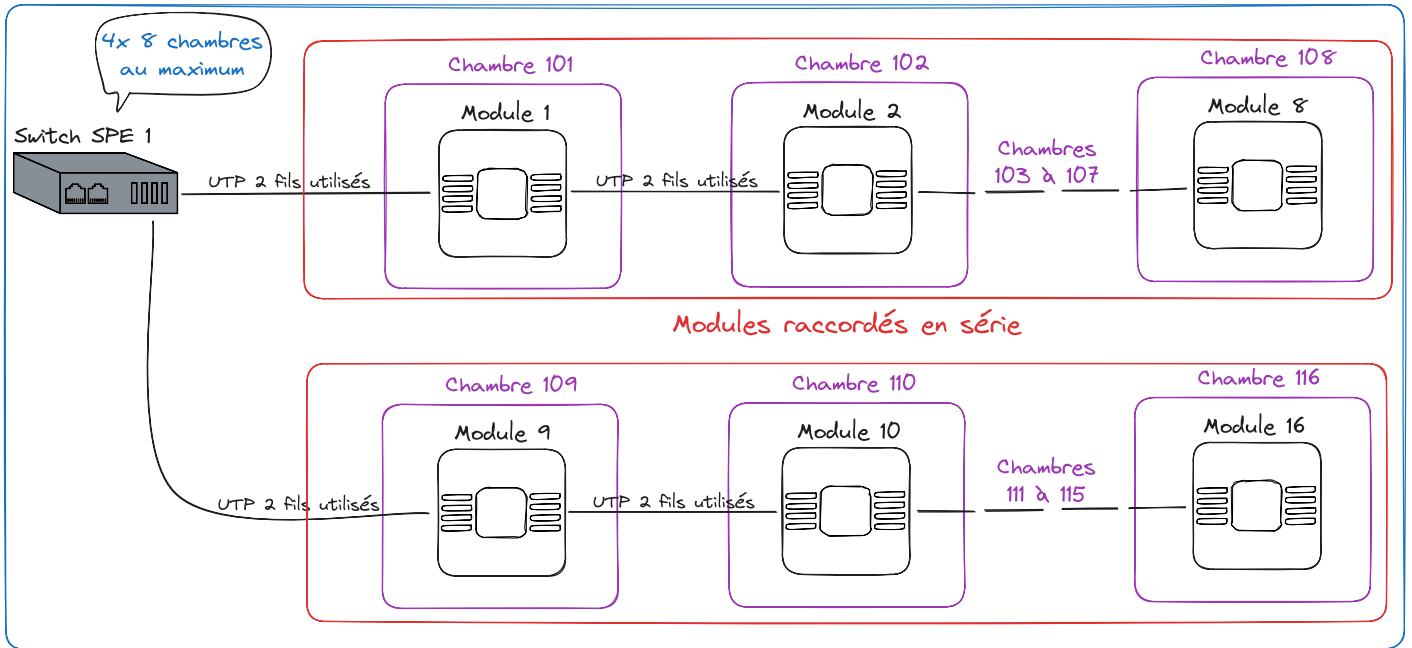

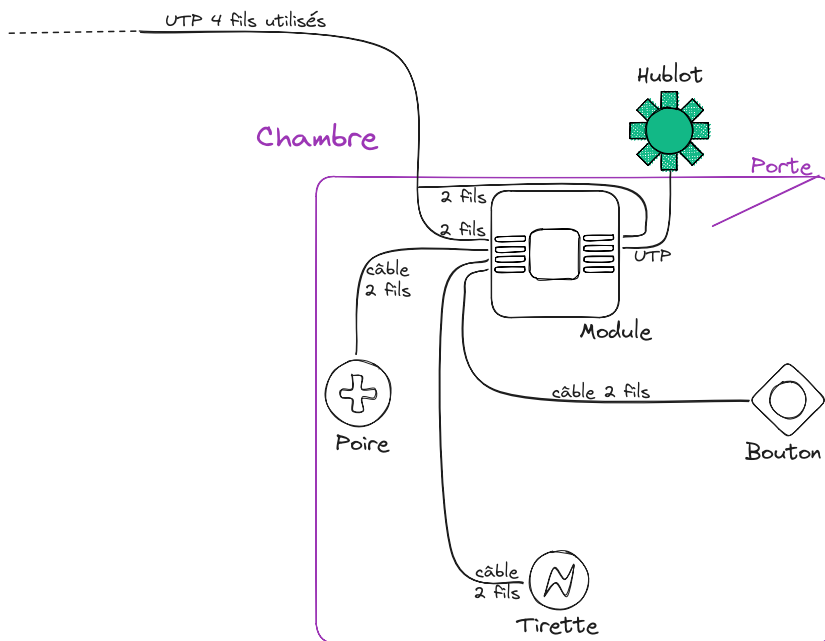
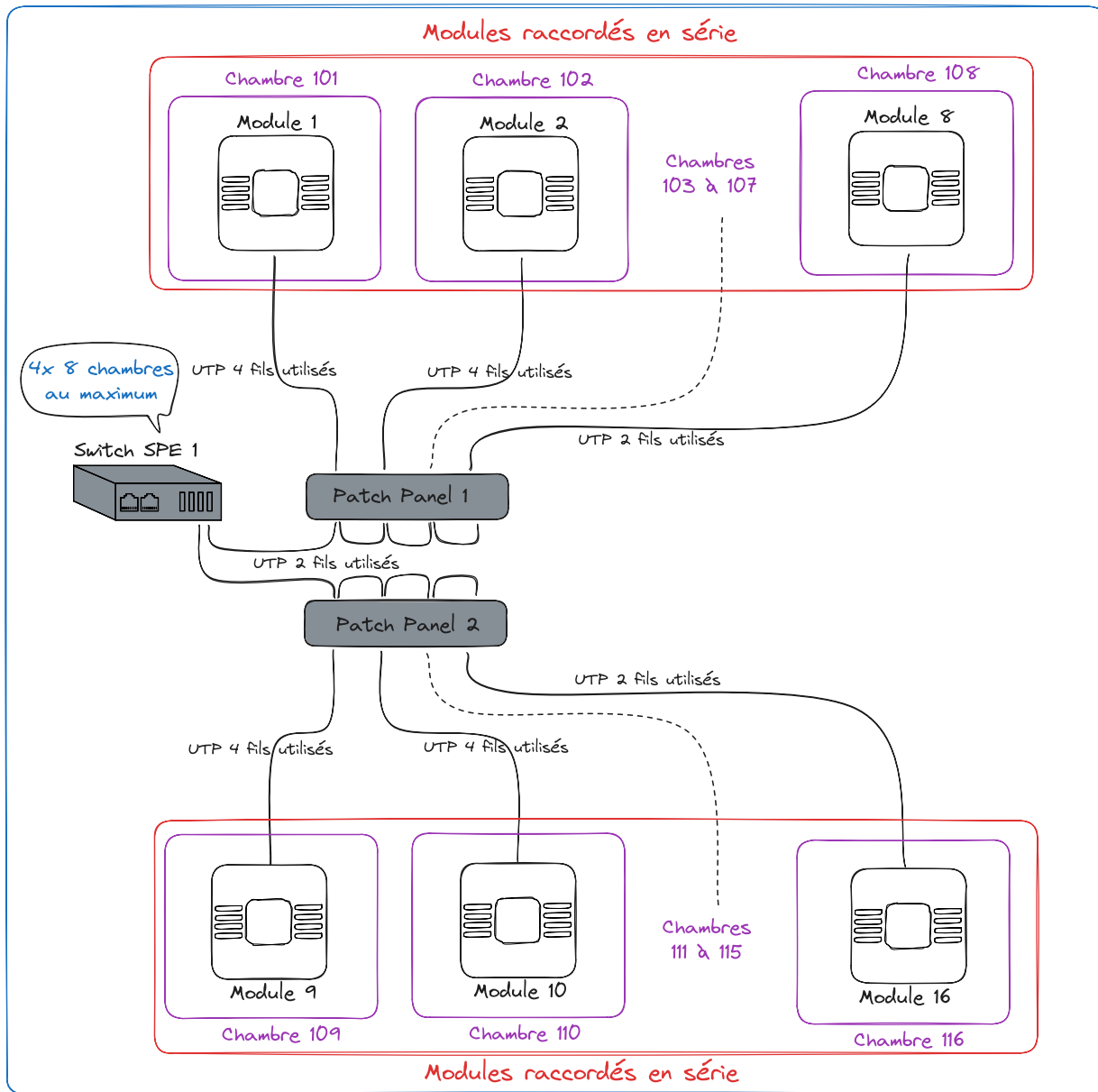

Gateway Sonitor

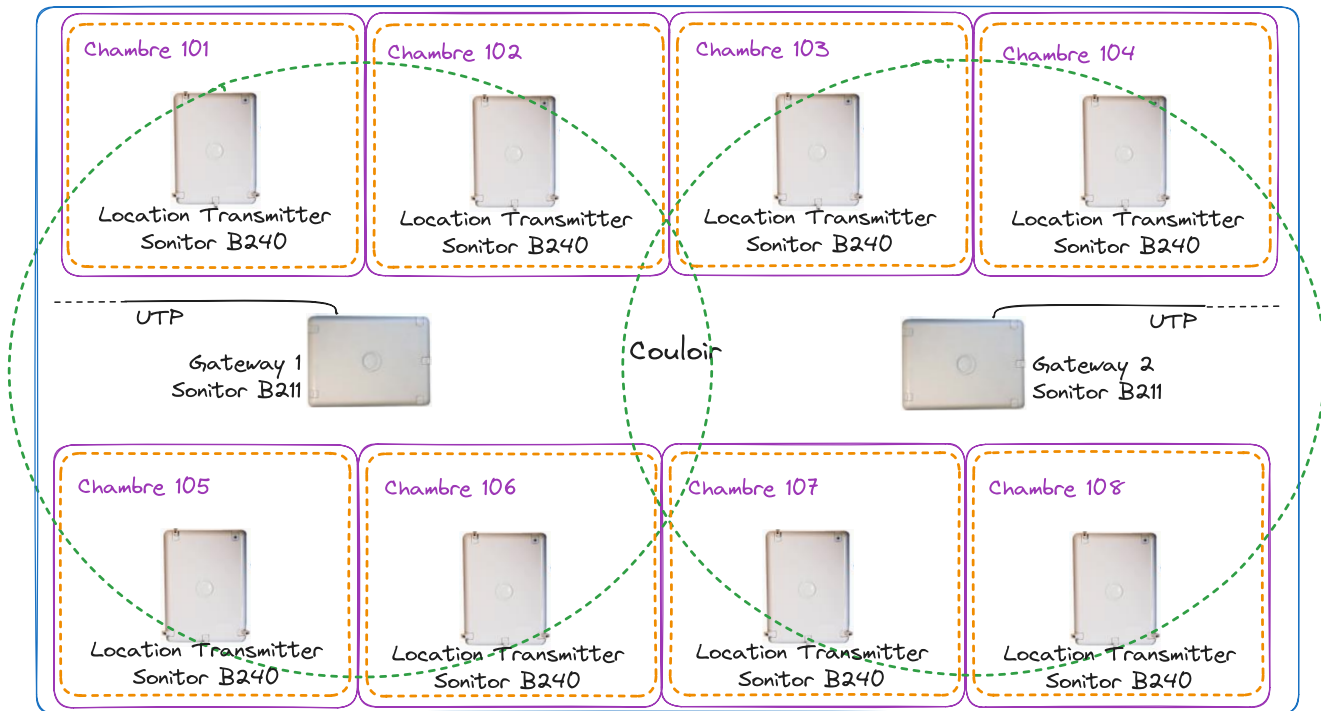
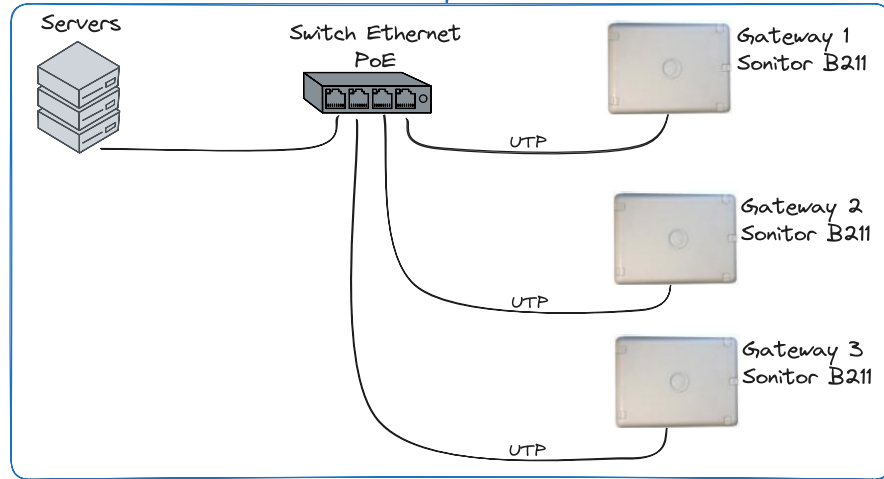

----- Limite de communication (ultrason) entre le Locator et les tags

----- Limite de communication (802.11) entre le Gateway et les Location Transmitters (10m max)